

Rotary Limit switch

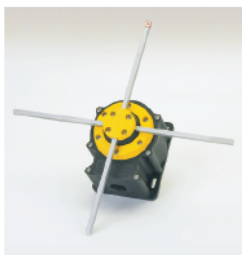

Generelt

- FCR rotations endestop til eksempelvis reversering af motorer, slow down og stop for kraner.
- 6 varianter
- Husmateriale : Selvslukkede thermoplast der opfylder V0 UL 94
- Kabelindgang via Ø22,5mm hul

Tekniske data

Opfylder IEC/EN60947-3, UL508
 Certificater
 Nom. Spænding 690V
 Nom. Strøm 16A
 Omgivelsestemperatur -25 - +55grc
 Tæthedegrad IP65
 Dobbeltisoleret

1 HASTIGHED

3 stillings med mekanisk interlock

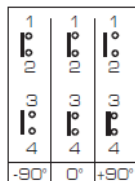
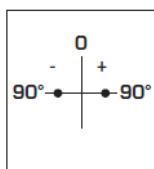

3 stillings med mekanisk interlock

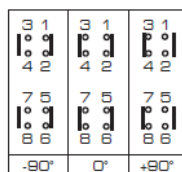
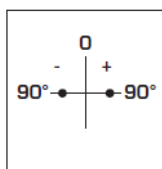

4 stillings roterende

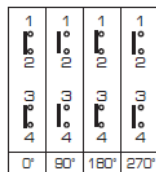
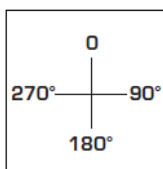

4 stillings roterende

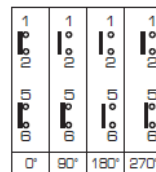
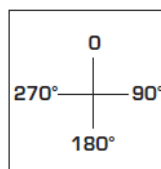

4 stillings roterende

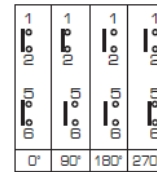
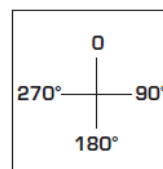

TYPE	VAREN./EANNR.	TYPE	VAREN./EANNR.	TYPE	VAREN./EANNR.	TYPE	VAREN./EANNR.	TYPE	VAREN./EANNR.
FCR001	8718234071285	FCR002	8718234071292	FCR003	8718234071308	FCR004	8718234071315	FCR005	8718234071322

2 HASTIGHEDER (SLOW DOWN)

MÅLKITSE

4 stillings med mekanisk interlock

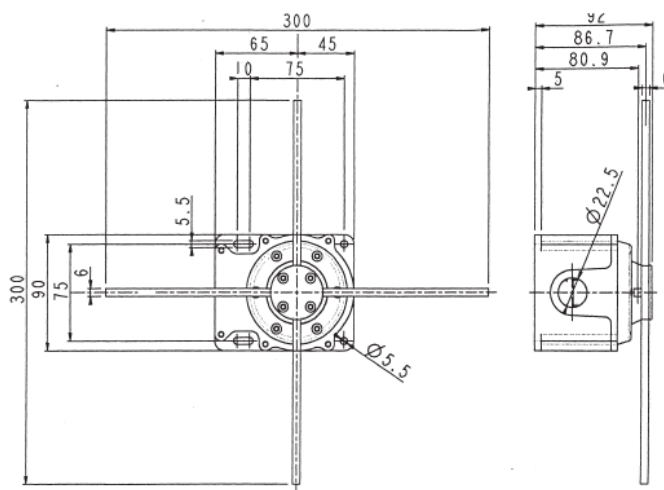
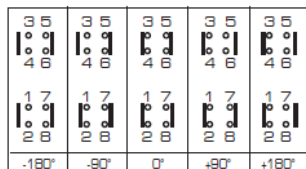
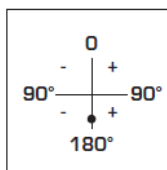

TYPE	VAREN./EANNR.
FCR006	8718234071339